

DESIGN: A BAKER	01/18/13	KG4JJH	
		BLUETOOTH RADIO ADAPTER ASSEMBLY	
		SCALE: 1:1	1 OF 3
			REV. 0

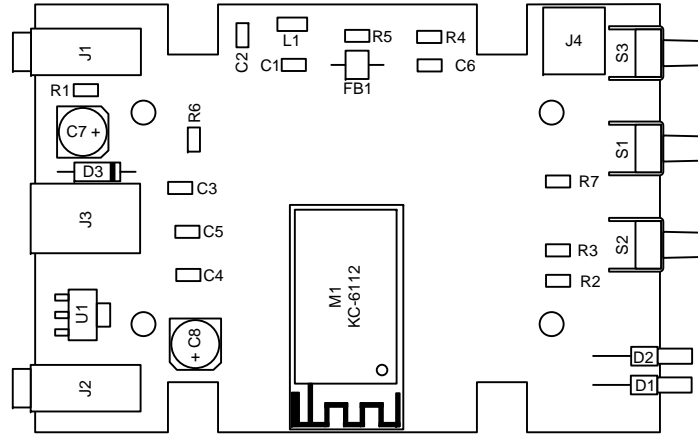

PC BOARD ASSEMBLY

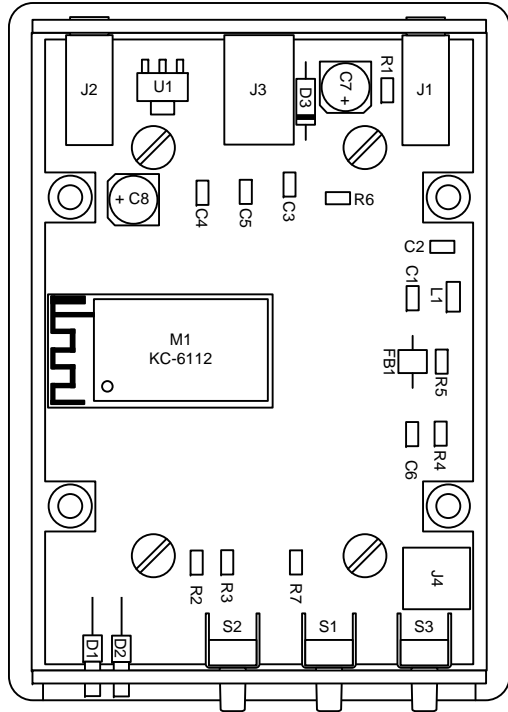
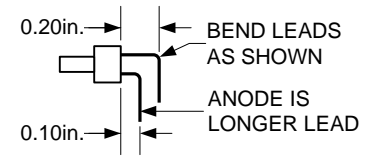

LED MOUNTING DETAIL

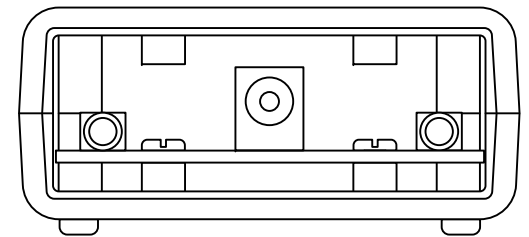
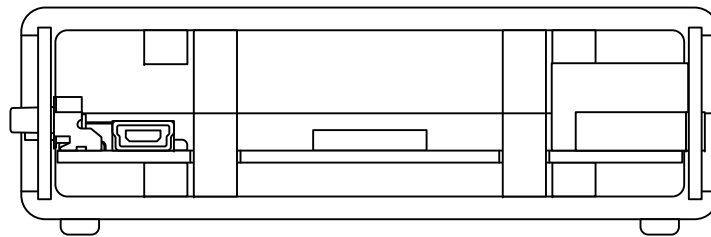
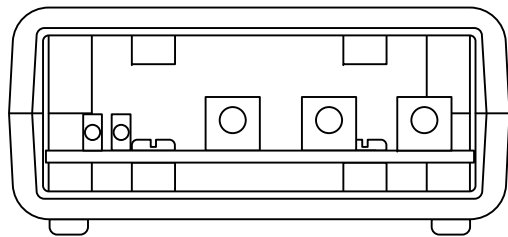

DESIGN: A BAKER	01/18/13	KG4JJH	
		BLUETOOTH RADIO ADAPTER DETAILS	
SCALE: 1:1	2 OF 3	REV. 0	

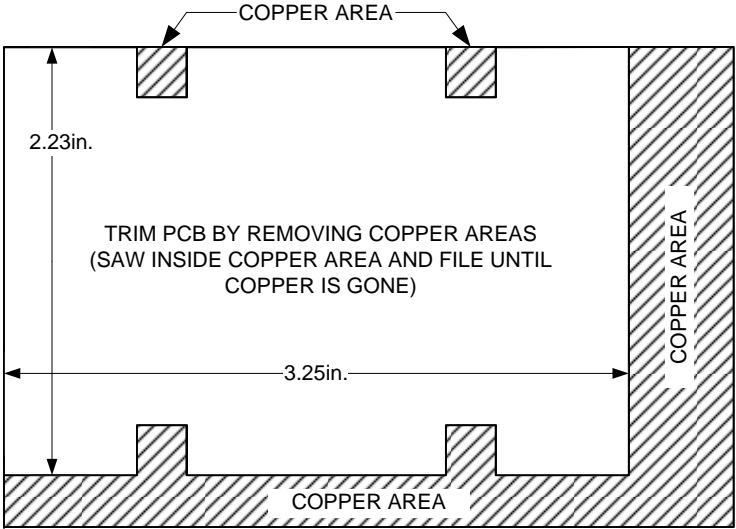

PC BOARD OUTLINE

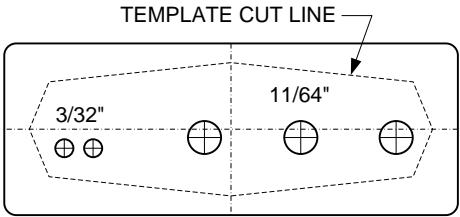

FRONT PANEL

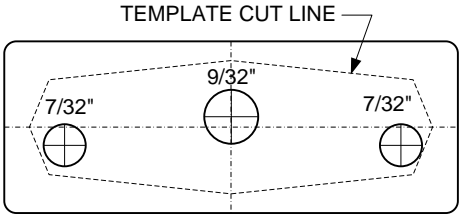

REAR PANEL

PRINT WITH ADOBE ACROBAT PAGE  
SCALING SET TO NONE

DESIGN: A BAKER	01/18/13	KG4JJH	
		BLUETOOTH RADIO ADAPTER CUTOUT & DRILL TEMPLATES	
SCALE: 1:1	3 OF 3	REV. 0	