

**W1CG**

# Low Power Balun



*Designed by:* **Charles Greene, W1CG**

*Kitted by:* the NJQRP Club

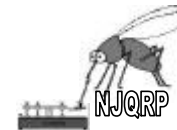

*Copyright 2002 by Charles Greene, W1CG and the NJQRP Club. All rights reserved.*

# A Low Power 4:1 Current Balun Kit

by Charles Greene, W1CG

w1cg@qsl.net

Over the last two years I have build, designed, tested and built many baluns -- and have had lots of fun doing it! The perfect, tiny, low loss balun still eludes me, however, but I keep on trying. One of earliest baluns I built just happened to have good performance. So I investigated its design features, improved its performance, rebuilt it using readily available materials, extensively tested it and I am presenting it here as a construction project for all homebrewers to enjoy.

## INTRODUCTION

The open wire balanced transmission line is widely used on wire antennas in an attempt to reduce losses and unwanted radiation from the transmission line and as a small lightweight alternative to coax for portable use. It benefits from a balun (BALanced to UNbalanced device) to convert the unbalanced output from an antenna tuner to the balanced input of the transmission line. The operator who wants a small, lightweight balun for back packing or fix station use for low power or QRP operation doesn't have much choice. Either he buys a large, heavy commercial balun or else searches the Internet for the design of a home brew balun, the performance of which is unknown. To help fill this void, this project concerns a small, low power 4:1 current balun that is easy to build and has good performance from 160 through 10 meters. A 4:1 balun is a good match for feeding an Off-Center-Fed antenna and performs well feeding an open wire transmission line, so that is the type presented.

## BACKGROUND

There are essentially two types of coiled transmission line baluns using ferrite or powdered iron cores. The first one was introduced by Guanella in 1944 and is known as the "current" balun. This balun consists of two coiled transmission lines with the inputs connected in parallel and the outputs in series. The impedance ratio is  $1:N^2$  where N is the number of wires making up the transmission line. Two wires have an impedance ratio of four times and three wires an impedance ratio of nine times, for example. Guanella also showed that when the transmission line is

coiled on a magnetic toroidal core or rod it is broader band than the uncoiled balun, and the length of the transmission line is less. As there are balanced currents in the transmission line, the net flux in the core is zero, so high efficiencies can be achieved. (Ref 1, Chap 1). A schematic of a 4:1 current balun is shown in Figure 1A.

In 1957, Ruthroff (Ref 1, Chap 1) used the property that a potential gradient exists along the length of a single transmission line to introduce the "voltage" balun. By connecting the wires so that the direct voltage adds to the delayed voltage, a 1 to 4 voltage ratio is achieved. A schematic of a 4:1 voltage balun is shown in Figure 1B. The years following the introduction of the voltage balun saw its increasing use over the more complex current balun. It is only recently that there is resurgence in use of the current balun due to its inherent advantages.

There are two problems with the voltage balun that limit its usefulness. Because its principle of operation depends on a phase shift in the voltage along a transmission line, the phase shift becomes inadequate to sustain the voltage ratio as the frequency increases. The second disadvantage is a result of the first. In an attempt to extend the high frequency range, fewer turns are used until there is barely adequate inductance for sufficient choking action to limit the primary current at the lowest frequency. Working into higher impedance makes matters worse as the choking impedance does not change and it becomes a smaller percentage of the total impedance. This causes too much of the wrong current to flow which decreases the

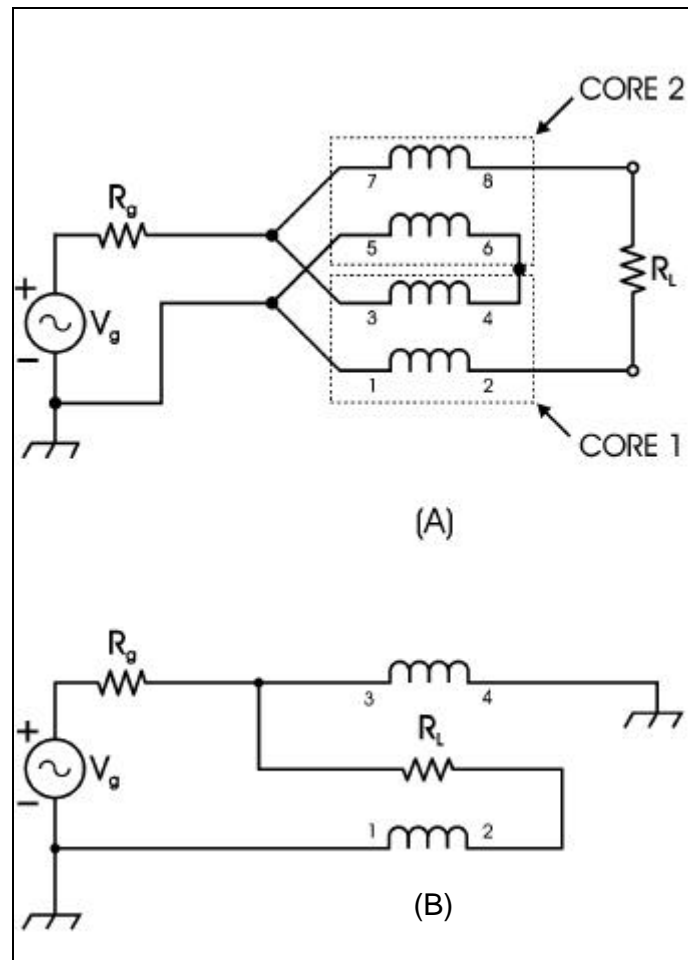
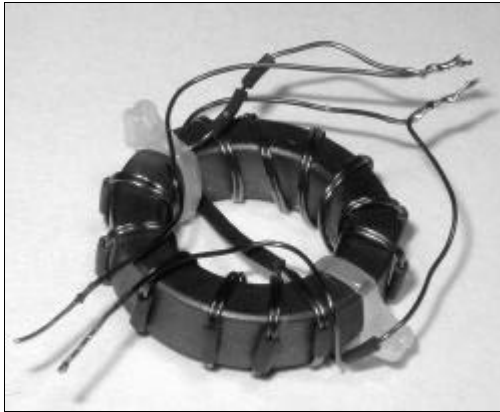

Figure 1. Two types of coiled transmission line 4:1 baluns using ferrite or powdered iron cores: (A) The Guanella or Current balun; a two core balun like the one described in the text is shown. (B) The Ruthroff or Voltage balun.

current to the load and increases losses.

The current balun operates on the principle of summing the voltages in each of four coils, and eddy currents in the windings limit its highest frequency. Therefore, more turns can be added until eddy currents start to limit operation at the highest frequency. The additional turns significantly increase choking action at the lower frequencies, and the effectiveness of the balun does not decrease as rapidly as that of the voltage balun when

working into a high impedance load. For example, the balun described in this article has a SWR of less than 1.08:1 into a non-inductive load of 200 ohms from 700 KHz to 30 MHz. I tested a single core of this two core current balun with the coils connected as a voltage balun (shown in Picture 1) and checked its frequency coverage. The low frequency performance of the voltage and current baluns is similar, but the performance of the voltage balun starts to fall off above 19 MHz. It has a SWR into a 200 ohm non-



**Picture 1. A single core of the two core current balun with the coils connected as a voltage balun.**

inductive load of 1.2:1 and higher above 19 MHz. In addition, Lewellen reported that his tests showed that the current balun has improved performance over the voltage balun under all conditions. (See Reference 4.)

#### A PRACTICAL DESIGN

Some design guidelines are set forth in the current literature (Ref 1, 2) for building high performance baluns. I will avoid the math and the theory and just use some approximations as practical guidelines. As can be seen from Figure 1A, when working into a balanced load, each pair of windings sees half the load  $Z_L$ : 100 ohms for a 50 to 200 ohm 4:1 balun. For best matching and power transfer, the  $Z_o$  of the coiled transmission line should equal the load, 100 ohms. The formula for transmission lines can be used to determine the wire size for close spaced wire. (I have found that the impedance of the transmission line wound on a toroidal core is approximately 80% of that in air). Close spaced #24 or #26 enamel insulated wire will produce the desired impedance, and can be used in a low power balun without danger of insulation breakdown. Actually some of the ferrite material toroidal cores are enamel insulated which increases the voltage breakdown safety factor.

A second guideline is that the minimum impedance of the inductance of the coil formed by the wound transmission line on the toroidal core  $Z_o$  should be ten times the impedance of the input transmission line  $Z_i$

at the lowest frequency to choke off the primary current. For the 50 to 200-ohm balun,  $Z_o$  should be 500 ohms at the lowest frequency. The inductance to produce this impedance at 1.8 MHz is 44 uh.

Now we will pick a size. For ease in construction and for a small balun for portable use, we will pick a size of about 1-inch. In order to get sufficient inductance (44 uh) we will need a material with a mid range permeability. We can not use low loss powdered iron material with permeability in the range of 1 to 75 because we cannot get enough turns of #24 or #26 enamel insulated wire on a 1-inch core for an inductance of 44 uh. A ferrite core of type 43 has an initial permeability of 850 and reasonable efficiency, and it is enamel insulated for a greater voltage breakdown safety factor. Using the formulas in the Amidon data book (Ref 3), we find that 15 turns bifilar wound which will easily fit on an FT114-43 core will produce an inductance of 136 uh. This is higher inductance than required but it will improve the performance of the balun when the load is higher than 200 ohms. The question is what the high frequency limit is.

The only way I know to determine the high frequency performance for sure is to build the balun and measure it. The high frequency performance of the 15-turn balun started to fall off at 10 meters (SWR started to increase into a non-inductive 200-ohm

load), but the SWR was low down to 500 KHz, which is well below the desired frequency. This indicates that the design should have fewer turns. So the next balun of the design had 13 turns. The 13-turn balun has an inductance of 101 uh and its SWR is low and is flat from 700 KHz to 30 MHz.

The wire size can be either #24 or #26 enamel insulated wire. I constructed a balun of each, and their performances are essentially the same. The #24 wire is easier to work with and has slightly less wire loss, so that is what we will use. To verify the wire size to give 100 ohms for  $Z_b$ , I wound a balun using #22 wire and measured its performance which was a little less than that of the other two. It had a somewhat higher SWR with a 200-ohm load. I also found the

#22 wire harder to work with than the #24 wire, and any improvement in wire loss would be slight. However, I resolved to check the loss of all three baluns during loss measurements, and use that as one of the criteria in selecting the wire size for the balun of design.

It is possible to construct a 4:1 current balun by winding both pairs of windings on a single core. However, in my experience, the performance of the single core 4:1 current balun is not as good as the two-core current balun. The SWR is high and is not flat across the HF spectrum. Therefore, this balun is wound on two FT114-43 cores (Figure 1A). Now that we have a preliminary design, we need to describe how to wind it and then test its performance.

## CONSTRUCTION

#### Parts List

- 2 Ferrite toroidal cores, FT114-43
- 6-ft #24 NYSOL magnet wire
- 6 4" nylon cable ties
- 1-ft 3/64" heat shrink tubing

#### Tools

- Vise (recommended)
- Large soldering iron or solder pot for insulation stripping
- Heat gun
- Common shop tools, including wire cutters, needle nose pliers, utility knife, and an ohmmeter.
- Optional: Antenna SWR analyzer and a 200 ohm 1/2 watt non-inductive resistor.

#### Construction Steps

- 1) Cut the wire into four 18" lengths. Cut thirty approximately 1/8" lengths and two 3/4" lengths from the heat shrink tubing.
- 2) Lead a cable tie around the core and one end of the wire pair about 3" from the end and tighten it. See Picture 2.
- 3) Clamp the core in the vise. Some people wind toroidal cores without a vise but holding the core in a vise allows one to use both hands. Use a cloth on the jaws of the vise to

prevent marring the surface of the core. Lead the long end of the wire pair through the hole and without twisting the wires pull them away from the core and cut them to the same length.

4) This is the first turn. Each time the wire passes through the center is counted as one turn. Place a 1/8" length of heat shrink tubing over the wire pair where it passes around the outside of the core to hold the wires closely together. Do not twist the wire, however, if the wire is inadvertently twisted it will not affect performance. See Picture 3.

5) Continue winding 6 turns spacing each pair about 1/4" on the outside. Pull the wires tight and form them over the edges of the core with your fingers. Use a 1/8" length of heat shrink tubing every time the wire pair crosses the outside of the core and heat shrink it. At the completion of 6 turns, adjust the wire spacing until the sixth turn is 180 degrees from the starting point.

6) For the seventh turn, lead the wire through the inside of the core back to the starting point. Place the 3/4" length of tubing on the wire pair where passes through the center of core and heat shrink it in place. Start winding back around the unused portion of the core.

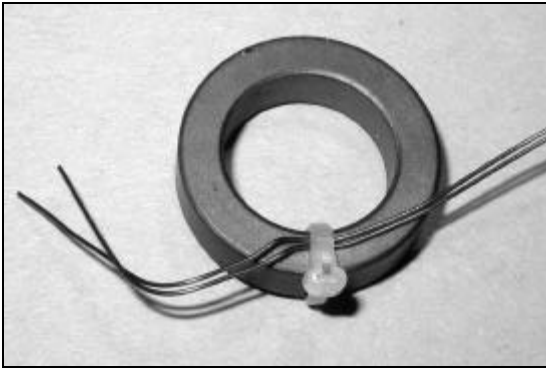

Picture 2: Lead a cable tie around the core and one end of the wire pair about 3" from the end and tighten it.

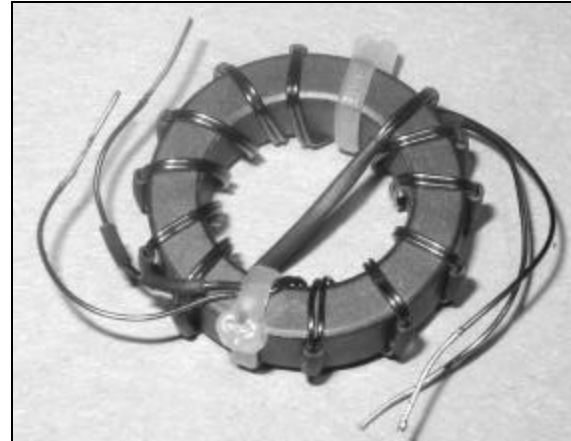

Picture 5: One completed core.

Picture 3: Balun core in vise showing heat shrink tubing on outside of windings.



Picture 6: Completed two-core 4:1 balun.

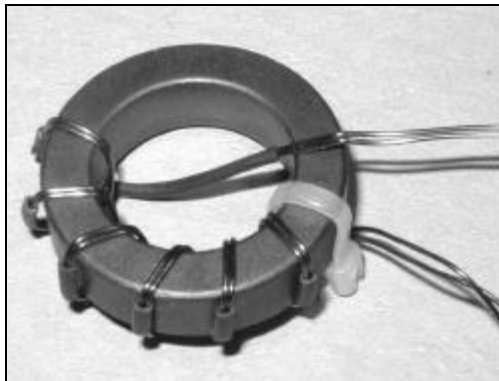
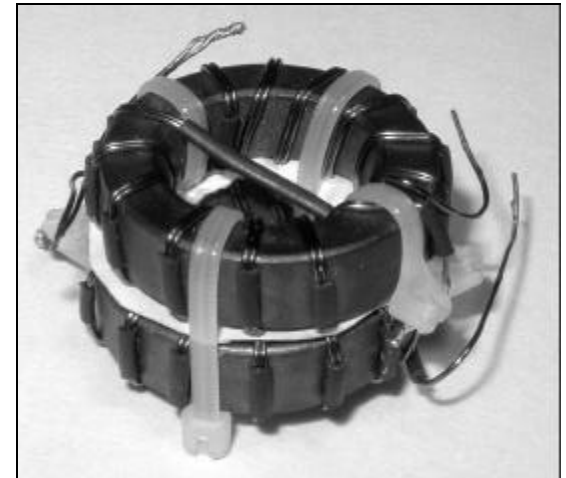

Picture 4: Balun core with six turns showing crossover on the seventh turn.

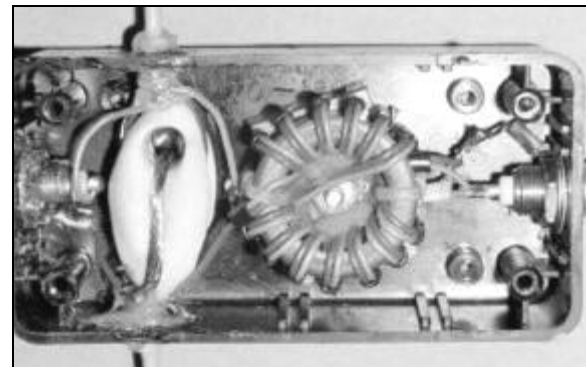

Picture 7: 14 turn version of balun in watertight enclosure for installation at top of Off Center Fed antenna.

(Full resolution color images available online at <http://www.njgrp.org/qhbextra/8/a>)

(Full resolution color images available online at <http://www.njgrp.org/qhbextra/8/a>)

See Picture 4. Continue winding six more, equally spaced turns and adding a 1/8" of heat shrink tubing on the outside of the core for each turn. (Note: Reisert, WIJR, used this winding technique with the "crossover" in his 1:1 balun. Ref 2. The purpose of the "crossover" is to facilitate connection of the input wires on one side of the balun and the output wires on the other side. It has no electrical significance.)

7) When done winding, the final turn should be about 180 degrees from the starting point. There should be six turns on each side counting every time the wire passes through the center as one turn. The crossover through the center counts as an additional turn but not one of the six on each side. Using a cable tie clamp the wires loosely to the core. Adjust the spacing evenly until the two cable ties are 180 degrees from each other then tighten the cable tie. Cut the finish ends of the wire to the desired length.

8) Strip a part of the insulation from about 1/4" on the end of each of the wires. Place the large soldering iron in the vise with the bevel of the tip horizontal and form a blob of solder on the tip. Thermaleze and Nysol wire will strip in this blob of solder, but it helps to have a bit of bare wire to better conduct the heat to start the stripping process. Insert the end of the wire to be stripped into the blob of solder and move it slowly through the blob. Add more solder to tin the stripped wire. You can also use a solder pot if you have one.

9) Place one of the 1/8" pieces of heat shrink tubing over one of the wires at the start end

and shrink it. Using the ohmmeter, identify the other end of this wire and shrink a 1/8" piece of tubing on it too. Now you have identified both ends of one wire, which we will use later to hook up to the second core. This completes one core. It should look like the one in Picture 5.

10) Wind the second core and mark the wires identically to the first.

11) Temporally connect the two cores as follows: On the input side, connect the two marked wires together and the two unmarked wires together. The 50-ohm input connects to these two wire pairs. On the output side connect one marked wire to one unmarked wire. The 200-ohm output goes to the two unconnected wires. Measure balun SWR using an antenna analyzer with a 200-ohm non-inductive resistor connected to the 200-ohm side and the antenna analyzer 50-ohm output connected to the input side. If you can't get the use of an antenna analyzer, connect the balun to your transceiver through an SWR meter, and reduce the power to the minimum and turn the rig on for a short time to get an SWR reading without burning up the 200-ohm resistor. The SWR should be in the range of 1.1:1. If not, check your connections.

12) Now you can secure the two cores together using the two remaining cable ties and solder the wires. It's a good idea to first insert a piece of paper between the cores with a hole in the center for the cable ties. Alternatively, you can cement the two cores together using silicon seal. It's not necessary to use Q-Dope to hold the wires in place. The Q-Dope reduces the Q somewhat and makes repair difficult. You can now attach connec-

## TESTING

tors to each end or place the balun in an enclosure of your choice. The completed balun is shown in Picture 6. Picture 7 shows a 14 turn version of the balun mounted in a watertight enclosure with a strain insulator for mounting at the top of an Off Center Fed antenna.

Tests consisted of measuring the inductance of the windings, SWR tests, loss tests and on-the-air tests using antennas with balanced feed lines with high SWRs. The most interesting tests were the efficiency tests. The efficiency tests consisted of measuring the temperature rise of the balun in a vacuum insulated thermos container with both a reactive and a non-reactive load and comparing it to the temperature rise of a resistor. Short lengths of RG-174 coax and a miniature 200-ohm transmission line served as the input/output leads passing through the top of the container to the device inside. A thermocouple with its own connecting wires leading to a meter was used to measure the temperature. The source of RF power was a Ten Tec Triton IV transceiver which can produce power from zero to 100 watts. A RF Power/SWR meter was used to measure output power output of the transceiver, and an antenna tuner was used to tune the output of the transceiver during high SWR tests. The output of the balun under test was connected to a calibrated dummy load through the impedance matching device. Figure 2 is a block diagram and Picture 8 is a photograph of the test setup, showing most of the equipment used.

For the non-reactive efficiency test, the 200-ohm output of the balun was connected to the 200-ohm side of a large commercial 4:1 balun. The 50-ohm side of the large balun was connected to the 50-ohm calibrated dummy load. Fifty watts was applied for a period of 10 minutes then reduced to zero for 10 minutes to avoid overheating the transceiver finals, then back on for 10 minutes. The temperature was allowed to stabilize for 10 minutes then measured. Then a 12-watt 50-ohm non-inductive resistor was

placed in the insulated container and low power applied with the same power on-off cycle and its temperature rise measured. I ran the test of the resistor several times with different power levels until the temperature rise of the resistor matched the temperature rise of the balun-under-test. Then power to the 12-watt resistor is the same as the power loss of the balun-under-test. Efficiency is 100% X power-loss / power-applied.

For the reactive load tests, the large balun was replaced with a Johnson KW Matchbox. The 200-ohm output of the balun-under-test was connected to the balanced output side of the Matchbox and the Matchbox 50-ohm input was connected to the calibrated dummy load. The Matchbox matching and tuning controls were adjusted for as high an impedance as could be read on the Autec VA1 antenna (715 ohms) on the balanced wire side of the Matchbox. In other words, the Matchbox was used in reverse. Power was applied in a similar manner to the non-reactive load tests and the temperature rise was compared to the temperature rise of the 12-watt resistor as in the non-inductive tests. Results of the efficiency tests are shown in **Table 2**.

The tests were fairly repeatable in that several runs of the same power gave temperature rise results within a few percent. The heat loss was very low and temperature readout accuracy was very good and its precision was 0.1 degree-F. The heat rise method is independent of all other losses in the system. The limiting factor is ability to read the power level accurately and hold it for the required time. The calibrated dummy load/wattmeter has a readout precision of two decimal points, but it could not be used except to check the accuracy of the other wattmeters when applying power to the balun and the 12-watt resistor.

The temperature rise of the balun in air is insignificant during normal operation and is hard to detect without a temperature-measuring instrument. The temperature rise of the balun in air using 100 watts CW for 10

**TABLE 1**  
**Tabulation of Efficiency Tests**

LOAD (type)	POWER (to balun)	POWER LOSS (in balun)	EFFICIENCY 100%X loss/input	LOSS (dB) 10log(100/efficiency)
200 ohm non-reactive	50 watts	1.5 watts	97%	0.12dB
High Z (See Note 1)	50 watts	3 watts	94%	0.27dB

**Note 1.** The load on the 200 ohm side of the balun-under-test was 517 + j494 ohms. Z = 715 ohms at frequency of 7.1 MHz. The SWR of the balun was 6.6 read on the 50-ohm side. There is not exactly a 1:4 relationship between the input to the output impedance, as the balun is not a transformer and will produce the 1:4 impedance ratio only with a 200-ohm load.

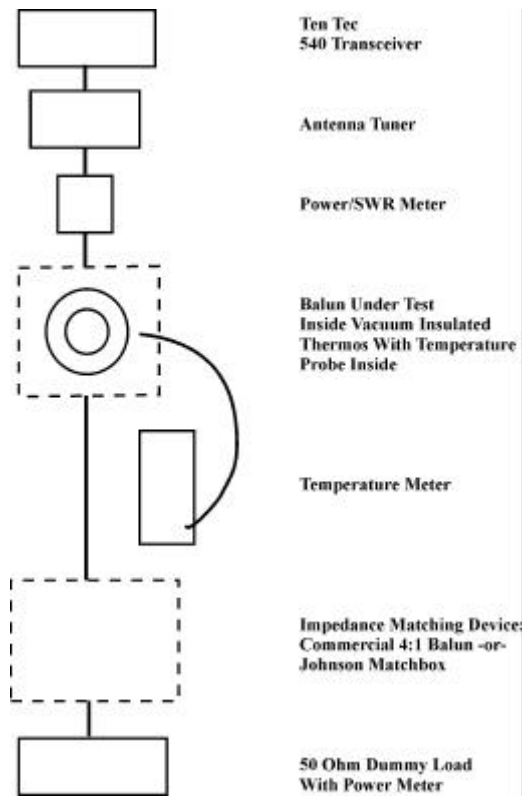

Figure 2: Block diagram of test setup.



Picture 8: Test setup showing some of the equipment used.

minutes with a 200-ohm non-inductive load was 7 degrees-F at 7.1 MHz and 15 degrees F at 28 MHz. With the 715 ohm reactive load used for the above efficiency tests the temperature rise in air was 16 degrees-F at 7.1 MHz.

The losses include  $I^2R$  and eddy current losses but are predominately dielectric and increase as the voltage gradient across the windings increase. The best efficiency is attained when the load impedance is 200-ohms. If the impedance load is extremely low,  $I^2R$  losses increase, decreasing efficiency again. As shown in table 1, the efficiency when operating into a non-reactive 200-ohm load is 97%. The loss is 3% or 0.12 dB. A loss of 0.12 decibels is insignificant compared to other losses in an antenna system, however, at 1000 watts 30 watts would be dissipated in the balun which is sufficient to burn up all but the larger baluns. The efficiency of the balun operated into the 714-ohm reactive load is 94%.

#### OPERATION

I have operated the balun at 100 watts CW and SSB with my W3EDP and G5RV antennas that have high impedances on some bands with barely perceptible heating. For a limit, the wire and heat shrink tubing are specified for a maximum temperature of 130 degrees C, and the Curie temperature (the temperature at which the ferrite material loses magnetic properties) is also 130 degrees C. For a rule of thumb, don't operate the balun if it is too hot to touch. The voltage breakdown specification of the wire or core insulation of 500 volts will be exceeded if the impedance exceeds 2500 ohms. (There is a voltage breakdown safety factor of two in the design but this is for the situation where there is a scratch in the insulation). By all means avoid the current node of an open wire transmission line at any power as the impedance can reach several thousand ohms at this point, an impossible condition for any balun. As a suggestion, operate the balun for a few minutes then check its temperature. If the balun is hot to the touch, reduce power or move the balun to a lower impedance point on your transmission line.

#### SUMMARY

Here is low power balun that everyone can build that gives reasonable performance over a wide impedance range for the entire HF band, 160 to 10 meters. The efficiency of the balun is less when operated into a high impedance reactive load and at higher frequencies, as was expected. The efficiency of the balun can be improved by using a lower permeability, less lossy core material, but the size of the core would need to be increased to achieve the desired inductance. This larger balun would be able to operate at a higher power level, and would no longer be a small, portable, low power balun.

#### REFERENCES

1. Sevick, J., "Transmission Line Transformers," Nobel Publishing Corporation, Atlanta, GA, Fourth Edition, 2001.
2. Sevick, J., "Building and Using Baluns and Ununs," CQ Communications, Inc., Hicksville, NY, 1994.
3. Amidon Associates, (no title data book), Costa Mesa, CA, Jan., 2000.
4. Lewellen, J., "Baluns: What They Do and How They Do It," The ARRL Antenna Compendium, Vol. 1, American Radio Relay League, Newington, CT, 1985, p 157-164.

#### CONTACTING US

- 1) Please be sure to check the online web pages for this project at the NJQRP website at [www.njqrp.org/balun](http://www.njqrp.org/balun). We often post additional information about the kits, construction feedback from users, errata, application notes, et.
- 2) For **technical questions**, please contact the designer at:  
*Charles Greene, W1CG*  
*115 Aaron Avenue*  
*Bristol, RI 02809*
- 3) **Any other questions** concerning this kit may be directed to the NJQRP Club:

*Dave Porter, AA3UR*  
*647 Middle Holland Road*  
*Holland, PA 18966*  
*email: aa3ur@comcast.net*

